

Article number: 2310431171S

Description: E+G Levelling elements  
LX.30-SW17-SST-M10X33-S

## Measures

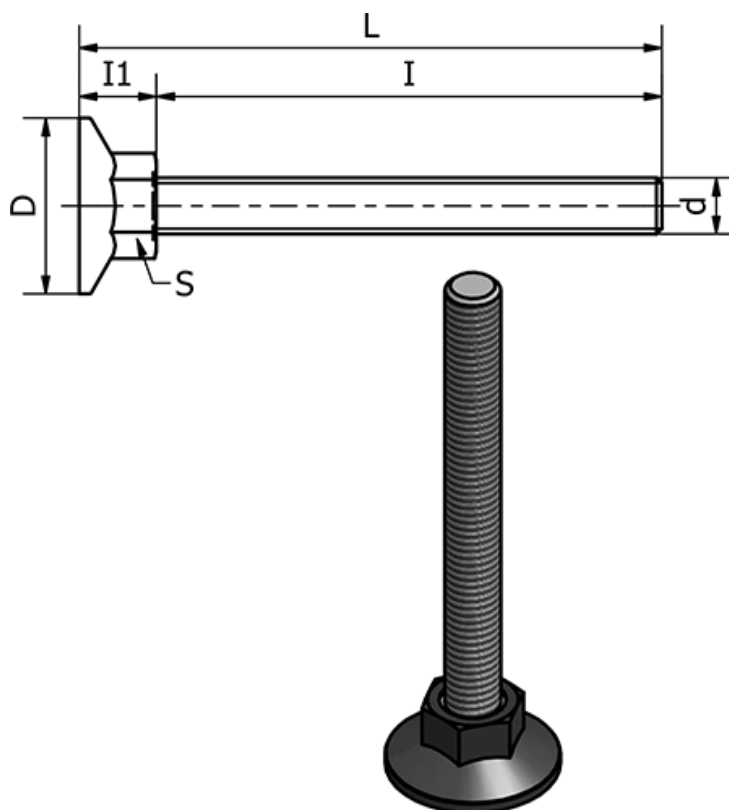

d = M10

D = 30

I = 33

I1 = 12

L = 45

S = 17

Static load in (N) = 3000

Type = AISI 304 Rustfast

Weight (g) = -